



Made in  
Britain

ERNEST H. HILL LTD • SHEFFIELD  
[www.hillpumps.com](http://www.hillpumps.com)

## USER INSTRUCTION MANUAL



## EC3000 PORTABLE AIR COMPRESSOR

# Contents

Parts Included	3
Set Up	4-5
Operating Instructions	5-8
Troubleshooting	9
Closedown	9
Storage	9
Maintenance	9



## IMPORTANT

THIS PRODUCT IS DESIGNED TO **FILL** PRE-CHARGED PCP AIR GUNS AND PAINTBALL GUNS DIRECTLY. IT CAN ALSO BE USED TO **TOP UP** SMALL BOTTLES. LARGE CYLINDERS/TANKS SHOULD ONLY BE FILLED BY COMPETENT/QUALIFIED PEOPLE.

**NOT FOLLOWING THE INSTRUCTIONS OR MISUSE OF THE COMPRESSOR WILL VOID YOUR WARRANTY AND MAY RESULT IN DEATH OR INJURY**



## DANGER

### DANGER OF EXPLOSION

**FROM OVERFILLING OF COMPRESSED AIR BOTTLES**



**DO NOT EXCEED MAXIMUM FILL PRESSURE OF YOUR BOTTLE AT ROOM TEMPERATURE. ONLY FILL BOTTLES THAT ARE IN GOOD CONDITION AND ARE IN DATE OF INSPECTION.**



## IMPORTANT

READ ALL INSTRUCTIONS BEFORE USE.  
TO PROTECT YOURSELF YOU SHOULD ALWAYS WEAR SAFETY GLASSES AND EAR PLUGS WHEN OPERATING THIS COMPRESSOR



## WARNING

THIS COMPRESSOR PRODUCES CLEAN AIR SUITABLE FOR FILLING PCP AIRGUNS. IT DOES NOT PRODUCE AIR SUITABLE OR CERTIFIED FOR BREATHING APPARATUS NOT USE IT TO FILL SCUBA TANKS THAT MAY LATER BE USED FOR BREATHING.

## Parts Included

1x EC-3000 Compressor

1x Power Cable

1x High Pressure Filling Hose 1/8" and male Quick Release Coupling

1x Hill A73 Crank Oil

1x Hill A72 Silicone Oil

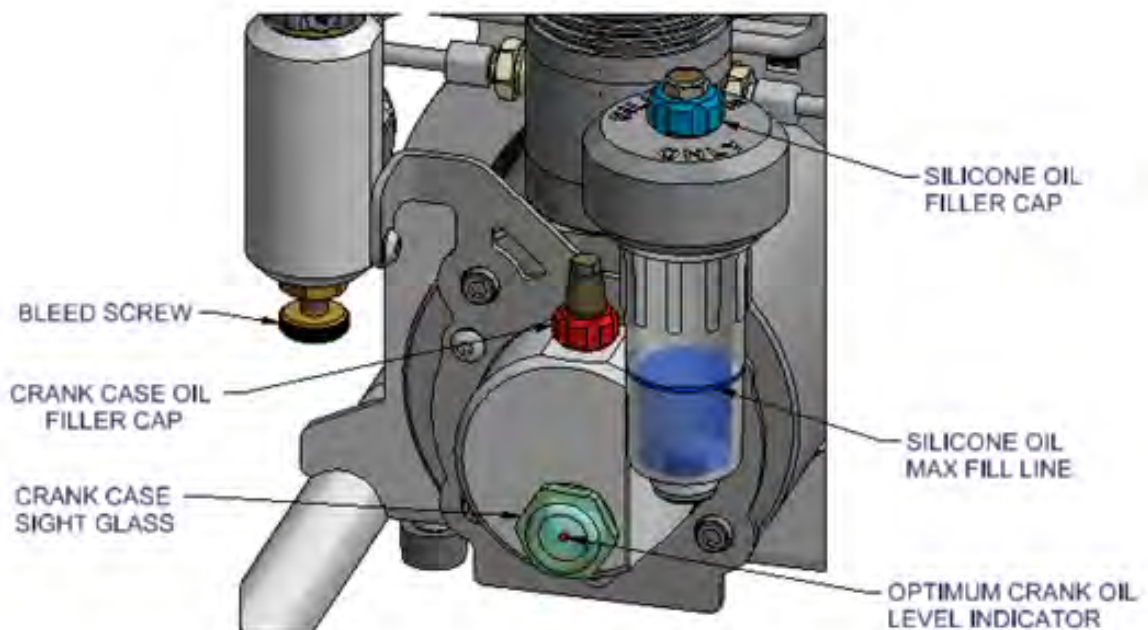
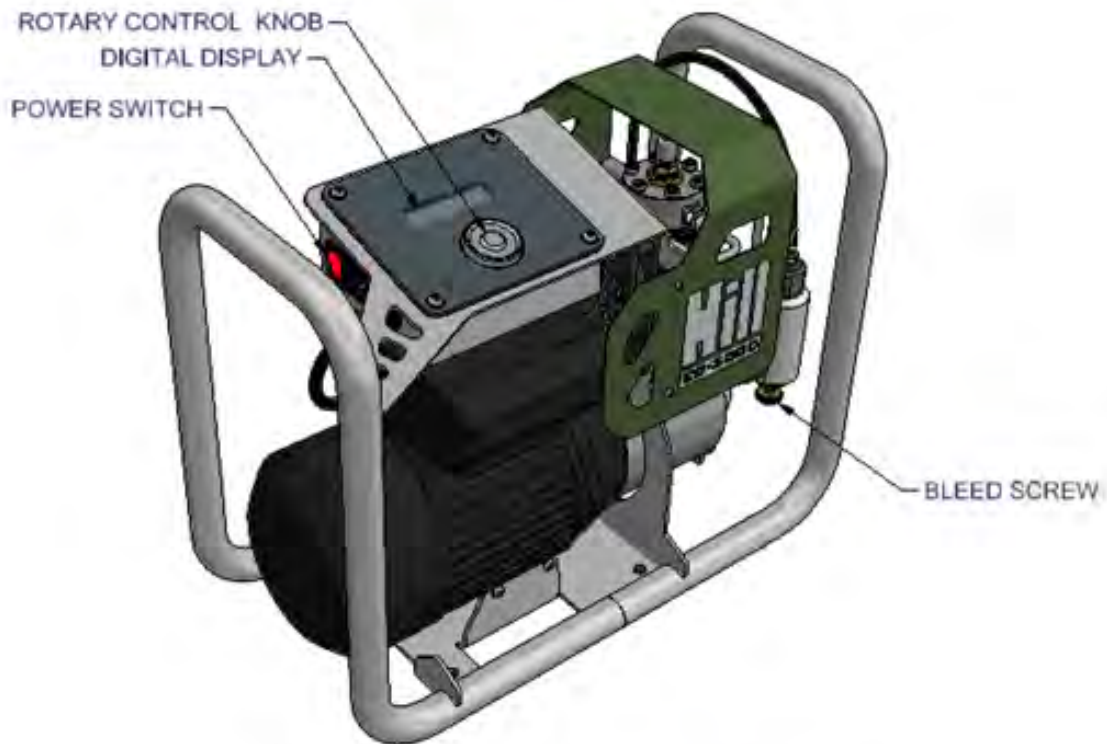

# Set Up

CAUTION - please read and understand the following instructions before use.

CAUTION - ONCE YOU HAVE CORRECTLY FILLED THE COMPRESSOR WITH LUBRICANTS, THE COMPRESSOR MUST BE KEPT UPRIGHT AND LEVEL AT ALL TIMES. ENSURE THE COMPRESSOR IS USED ON A NON-SLIP FLOOR, PREFERABLE SAT ON ANTI-SLIP MATTING. IF THE COMPRESSOR IS TO BE MOVED OR TRANSPORTED FOR STORAGE OR MAINTENANCE, ENSURE ALL LUBRICANTS ARE DRAINED FIRST.

## 1. Oil Level

With the compressor positioned on a level surface, check that the oil level meets the red dot on the sight glass.

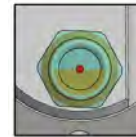

Top up as necessary using the following:

Remove red cap - screw anti-clockwise



Slowly squeeze the A73 crank oil into the exposed hole until the lubricant level meets the red dot in the sight glass this should use more or less the complete bottle

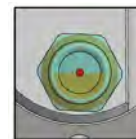

DO NOT MIX CRANK OIL AND SILICONE OIL AND DO NOT OVERFILL



After an oil change or fill...

Leave the oil to settle for 5 mins, if the oil level drops below the red dot apply more oil until the oil level is maintained

Replace the red cap until finger tight

## 2. Silicone Lubricant Level

Fill the lubricant reservoir using the following:

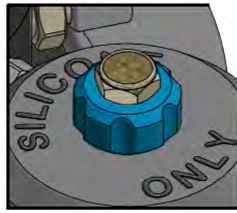

Remove blue cap - screw anticlockwise

Slowly squeeze the Hill A72 Silicone Oil through the exposed hole until the oil reaches the limit indicated on the reservoir by the blue line

**DO NOT MIX CRANK OIL AND SILICONE OIL**

Replace blue cap until finger tight

## 3. Power connection and Operating Instructions

Connect filling probe to hose, ensure spanner tight or use Quick Release Coupling fitted



Connect filling probe to bottle or gun and ensure spanner tight



Ensure bleed screw is closed (finger tight)



Insert power cable into pump



**⚠ CAUTION:** If using a quick release release coupling, always check and make sure the collar on the female quick disconnect is in the forward position and secure on the male fitting you are connecting it to. It is recommended that you check the connection by attempting to pull the female and male ends apart while the collar on the fitting is in the forward position before pressurising.

Please avoid using any electrical extension leads if possible. However, if you must use a 3rd party extension lead, this must be as short as possible and must be rated to a minimum of 110v/16A or 230v/13A depending on your local power supply. If unsure, please determine what your local power supply is before operating the compressor.

Switch compressor on



The screen will briefly show the Hill logo, the software version and the accumulated running hours...



...before requesting confirmation that the lubricant levels have been checked and are correct.



Press the rotary control knob to confirm the lube check.



The display will then change to “set pressure”. A default pressure of 100BAR (1450PSI/10MPa) is displayed.



If you are using the compressor for the first time, the unit of measure will display in BAR. To change the unit of measure to PSI or MPa, rotate the control knob clockwise and press to confirm



Rotate the knob again to alternate between BAR, PSI and MPa. When you have chosen the unit of measure, press the control knob to confirm. The chosen unit of measure will be retained for future use even when the compressor is switched off. This can be changed at any time.

To return to the “set pressure” screen, rotate the knob anticlockwise and press to confirm.

To set the pressure, rotate the control knob clockwise to increase the fill pressure required. When you reach the desired pressure, press the control knob to confirm.

The maximum pressure that can be set is 300BAR

(4350PSI/30MPa). **DO NOT SET THE COMPRESSOR ABOVE THE MANUFACTURER'S RECOMMENDED PRESSURE FOR THE BOTTLE YOU ARE FILLING.** As a safety feature the target pressure is not retained and will require resetting each time.



Rotate the control knob to reach the start display  
Press the control knob and the compressor will commence filling.  
The display will show the operating temperature, the current working pressure and the target set pressure.

You can manually pause the filling at any time by pressing the rotary control knob once, the display will show "Fill Abort?"

You can either confirm the fill abort by depressing the control knob once more or to resume the fill,



rotate the control knob once more to show "Fill Resume" and then press the knob to confirm.

The compressor is programmed to only operate within a pre-set temperature range. The compressor will automatically pause if the working temperature exceeds this pre-set. **This is normal and no operator intervention is required.** The display will show the progress of the cooling cycle and when the working temperature falls below the pre-set the compressor will restart. If you are filling a larger bottle, this could happen multiple times. You can abort the fill at any time within the cooling cycle if required.



When the target pressure is reached the display will show "Fill complete" along with confirmation of the achieved pressure and the target pressure.

**DO NOT** disconnect the bottle until the compressor has been depressurised.

Depressurise by unscrewing the bleed screw. Whilst depressurising, the compressor may expel some moisture and silicone from the moisture trap. **Suitable precautions should be taken to protect any floor coverings under the compressor.**



The display will show the progress of the depressurisation until it confirms depressurised. You can then disconnect the bottle.



The display will revert to the “set required pressure screen”.





The compressor will occasionally automatically stop and request that you check the lubricant levels. The compressor will not restart until you press the control knob. At this time you must bleed the moisture trap. If connected to a bottle without a non-return valve, close the valve on the bottle and bleed the EC3000 using the bleed screw at the bottom of the silver moisture trap. If your rifle or bottle has a non return valve you can just bleed the EC3000 as above. If in a very humid part of the world, you will need to bleed the moisture trap more often.

DO NOT LEAVE THE COMPRESSOR UNATTENDED WHEN IN USE!

IN THE UNLIKELY EVENT THAT YOUR COMPRESSOR MALFUNCTIONS, DO NOT ATTEMPT TO FIX THE PROBLEM YOURSELF. PLEASE CALL THE DISTRIBUTOR YOU PURCHASED IT FROM.

PLEASE RETAIN THE ORIGINAL RECEIPT OF PURCHASE

The most up to date version of this instruction manual will be available at: [www.airriflepump.com](http://www.airriflepump.com) Please check this website regularly

	<b>WARNING</b>	This compressor features 5000psi burst disks for backup over-pressure protection. These burst disks can be replaced with equal or lower pressure burst disks if required but NOT with higher pressure ones. Always ensure appropriate measures are in place to prevent over-pressurisation of vessels.
	<b>DANGER</b>	<b>DANGER OF ELECTRIC SHOCK</b> DO NOT OPERATE OUTSIDE IN THE RAIN DO NOT OPERATE WITH WET HANDS OR WET CLOTHES
	<b>DANGER</b>	PARTS OF THIS COMPRESSOR GET VERY HOT. DO NOT TOUCH THESE HOT PARTS
	<b>WARNING</b>	DO NOT TOUCH MOVING PARTS, FOR EXAMPLE THE COOLING FAN. KEEP FINGERS AND LOOSE CLOTHING AWAY FROM MOVING PARTS
<b>OPERATING TEMPERATURE +5°C to 75°C (41°F to 167°F)</b>		
THERMAL PROTECTION WILL NOT ALLOW THE UNIT TO START OUTSIDE THIS RANGE		



## Troubleshooting

### - Compressor will not start

Make sure that the power cable is inserted correctly and that the compressor is switched on, check that the fuse in the switch has not blown.

### - Pressure does not exceed 50BAR and air escapes from the Pressure Relief Valve

With the bleed screw open, run the compressor for 5 mins and then attempt another fill. If the problem persists contact your retailer..

### - Pressure achieved in the bottle is lower than the target pressure

Bottle valve may cause small pressure loss, adjust pressure on compressor to compensate.

## Shutting the compressor down

Make sure that the cylinder is removed and bleed screw is opened to release pressure.

## Storage

Keep upright at all times. Do not store below 5°C (41°F)

## Maintenance

Change crank oil every 50 running hours or once yearly (whichever comes first)

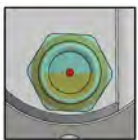

Unscrew sight glass to change Crank Oil (make sure you have a suitable container underneath) and drain.

Regularly check that the Silicone lubrication is free from dirt and debris

### **ERNEST H. HILL LIMITED**

LONGACRE WAY - HOLBROOK - SHEFFIELD S20 3FS - ENGLAND

Telephone; +44 (0) 114 248 4882

[www.hillpumps.com](http://www.hillpumps.com)

[sales@hillpumps.com](mailto:sales@hillpumps.com)